

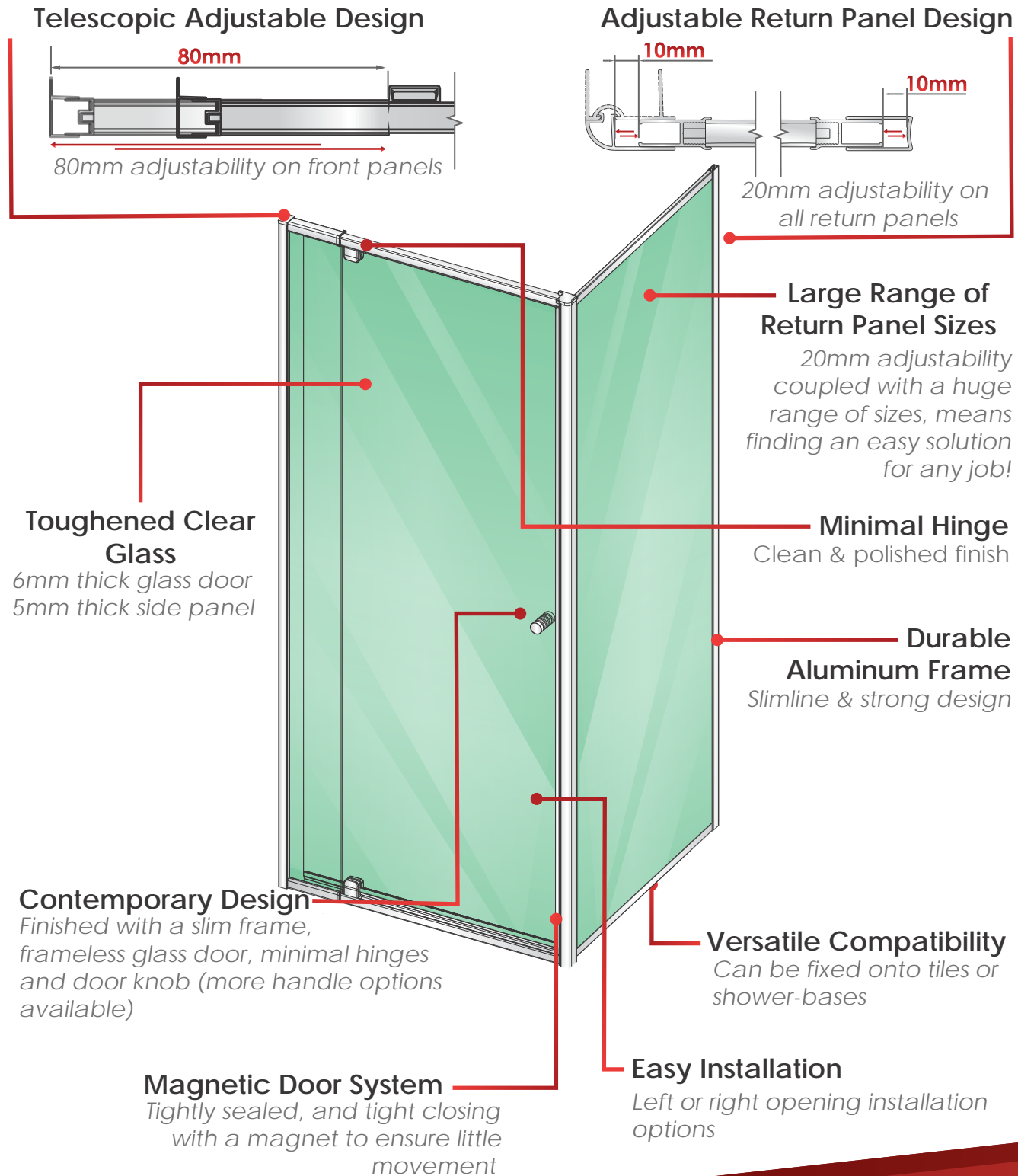

EDEN SHOWER SCREENS SYSTEMS



Eden Shower Screen System



Eden Shower Screen System

Front Panels

Sizes:

- ▶ **EDEN-T740:** 1950mmx740mm
- ▶ **EDEN-T820:** 1950mmx820mm
- ▶ **EDEN-T900:** 1950mmx900mm
- ▶ **EDEN-T980:** 1950mmx980mm
- ▶ **EDEN-T1060:** 1950mmx1060mm
- ▶ **EDEN-T1140:** 1950mmx1140mm
- ▶ **EDEN-T1220:** 1950mmx1220mm
- ▶ **EDEN-T1300:** 1950mmx1300mm
- ▶ **EDEN-T1380:** 1950mmx1380mm
- ▶ **EDEN-T1460:** 1950mmx1460mm
- ▶ **EDEN-T1540:** 1950mmx1540mm

All panel sizes have a +80mm adjustable capability

Return Panels

Sizes:

- ▶ **EDEN-R750:** 1950mmx750mm
- ▶ **EDEN-R770:** 1950mmx770mm
- ▶ **EDEN-R790:** 1950mmx790mm
- ▶ **EDEN-R810:** 1950mmx810mm
- ▶ **EDEN-R830:** 1950mmx830mm
- ▶ **EDEN-R850:** 1950mmx850mm
- ▶ **EDEN-R870:** 1950mmx870mm
- ▶ **EDEN-R890:** 1950mmx890mm
- ▶ **EDEN-R910:** 1950mmx910mm
- ▶ **EDEN-R930:** 1950mmx930mm
- ▶ **EDEN-R950:** 1950mmx950mm
- ▶ **EDEN-R970:** 1950mmx970mm
- ▶ **EDEN-R990:** 1950mmx990mm
- ▶ **EDEN-R1010:** 1950mmx1010mm
- ▶ **EDEN-R1030:** 1950mmx1030mm
- ▶ **EDEN-R1050:** 1950mmx1050mm
- ▶ **EDEN-R1070:** 1950mmx1070mm
- ▶ **EDEN-R1090:** 1950mmx1090mm
- ▶ **EDEN-R1110:** 1950mmx1110mm
- ▶ **EDEN-R1130:** 1950mmx1130mm
- ▶ **EDEN-R1170:** 1950mmx1170mm
- ▶ **EDEN-R1190:** 1950mmx1190mm

All panel sizes have a +20mm adjustable capability

Customisation

Not only is our Eden shower system available in huge range of sizes, and is a cost effective solution, but it is also compatible with our large range of shower door handles!

Choose the exact look you want to execute and have your bathroom look better than ever!



frameless
direct
architectural glass and hardware



EDEN IN-LINE SYSTEM

Eden In-Line Series

3D View

Polished Frame

Black Frame



Top View

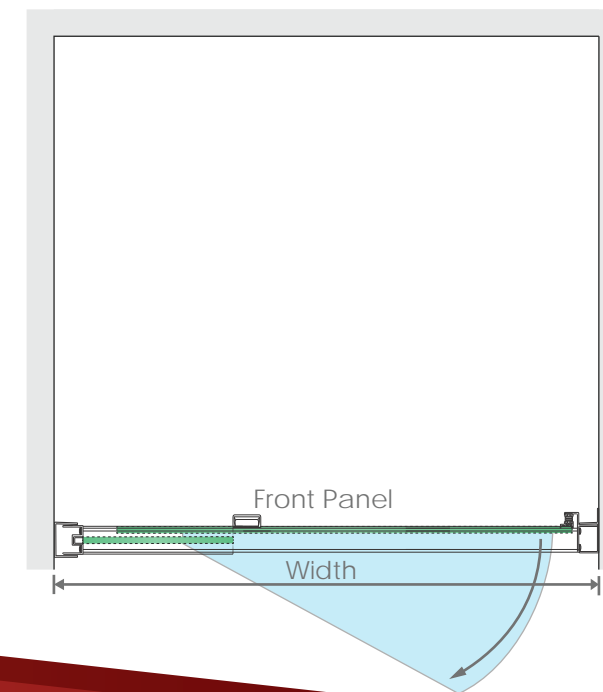

Available Configurations

EDEN-T740 (P-Silver) & EDEN T-740B (Black)

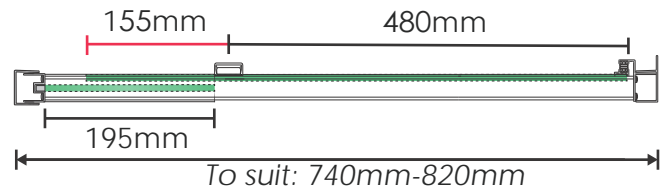

EDEN-T820 (P-Silver) & EDEN T-820B (Black)

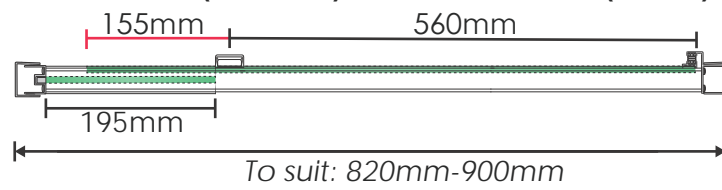

EDEN-T900 (P-Silver) & EDEN T-900B (Black)

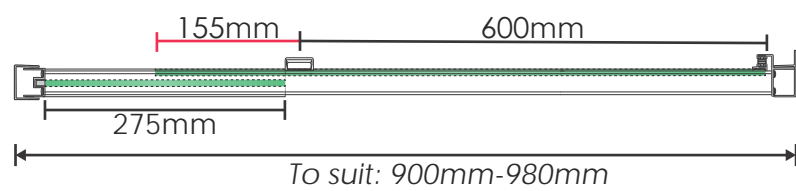

EDEN-T980 (P-Silver) & EDEN T-980B (Black)

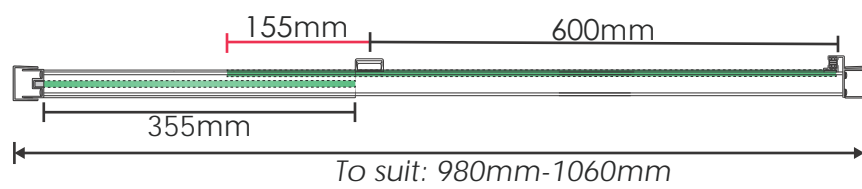

EDEN-T1060 (P-Silver) & EDEN T1060B (Black)

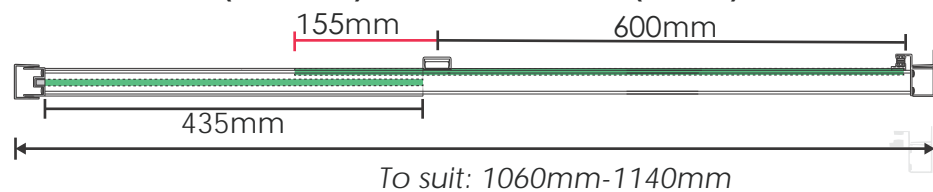

F-Channel for easy mount!

Installations that fit the following dimensions require, and include, an F-channel:

- ▶ EDEN-T740: 740-765mm
- ▶ EDEN-T820: 820-845mm
- ▶ EDEN-T900: 900-925mm
- ▶ EDEN-T980: 980-1005mm
- ▶ EDEN-T1060: 1060-1085mm
- ▶ EDEN-T1140: 1140-1165mm
- ▶ EDEN-T1220: 1220-1245mm
- ▶ EDEN-T1300: 1300-1325mm
- ▶ EDEN-T1380: 1380-1405mm
- ▶ EDEN-T1460: 1460-1485mm
- ▶ EDEN-T1540: 1540-1565mm

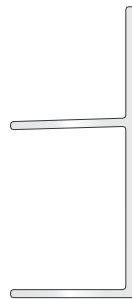

Available Configurations

EDEN-T1140 (P-Silver) & EDEN T-1140B (Black)

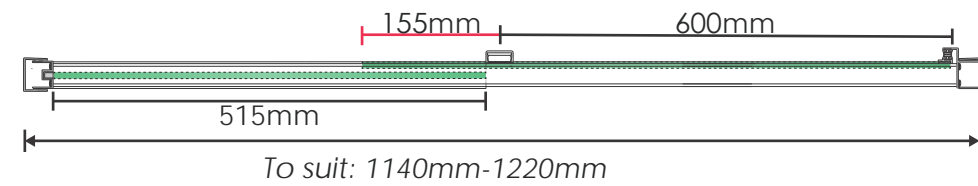

EDEN-T1220 (P-Silver) & EDEN T-1220B (Black)

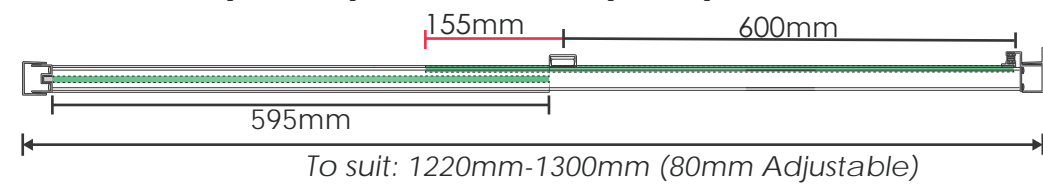

EDEN-T1300 (P-Silver) & EDEN T-1300B (Black)

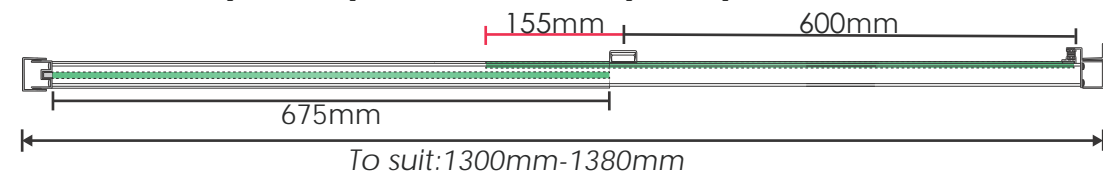

EDEN-T1380 (P-Silver) & EDEN T-1380B (Black)

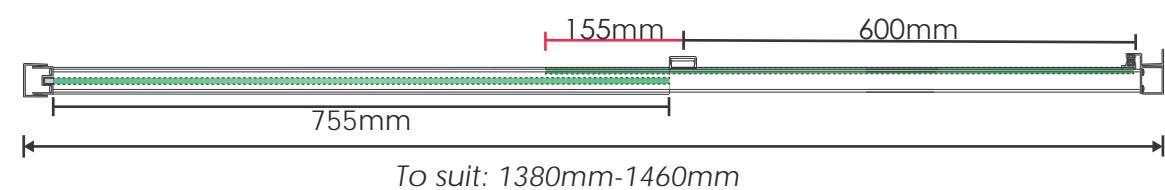

EDEN-T1460 (P-Silver) & EDEN T-1460B (Black)

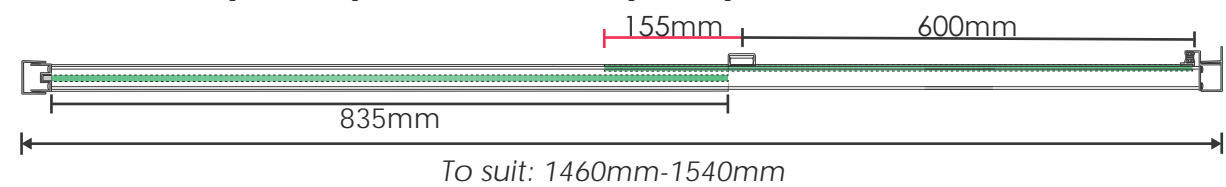

EDEN-T1540 (P-Silver) & EDEN T-1540B (Black)

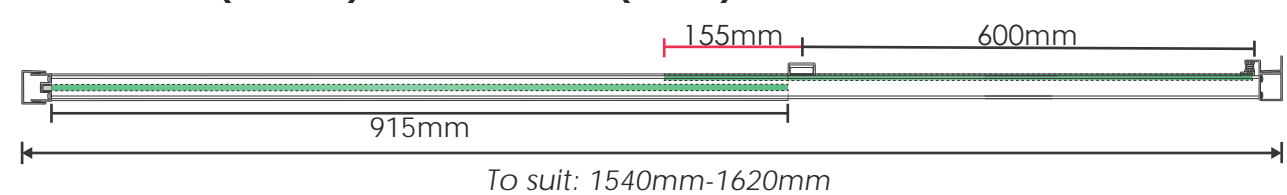

Adjustability

Versatility

The Eden range is made to be a cost-effective, and easily installed system, utilising an adjustable front to ensure this is achieved! With 80mm of adjustability, and 7 different base sizes (pictured on the left), there is a size to fit any bathroom.

As shown in the diagram below, the side panel, before the pivot of the door, slides up and down, allowing you to fully control where the frame starts and finishes! The outer clips also have room for movement, so if you're looking for a little more wiggle room, then we've got you covered!

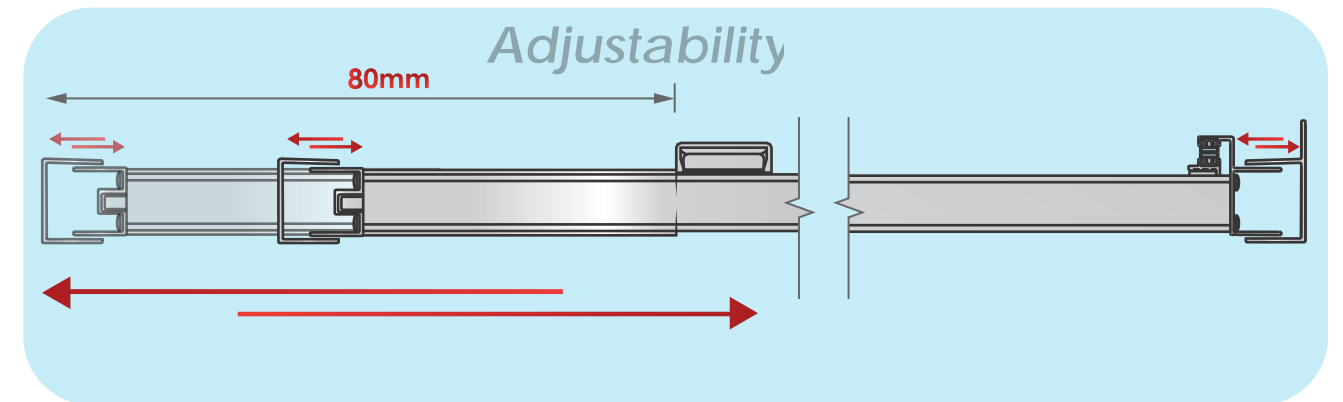



frameless
direct
architectural glass and hardware



EDEN SQUARE SYSTEM

Eden Square Series

3D View



Top View

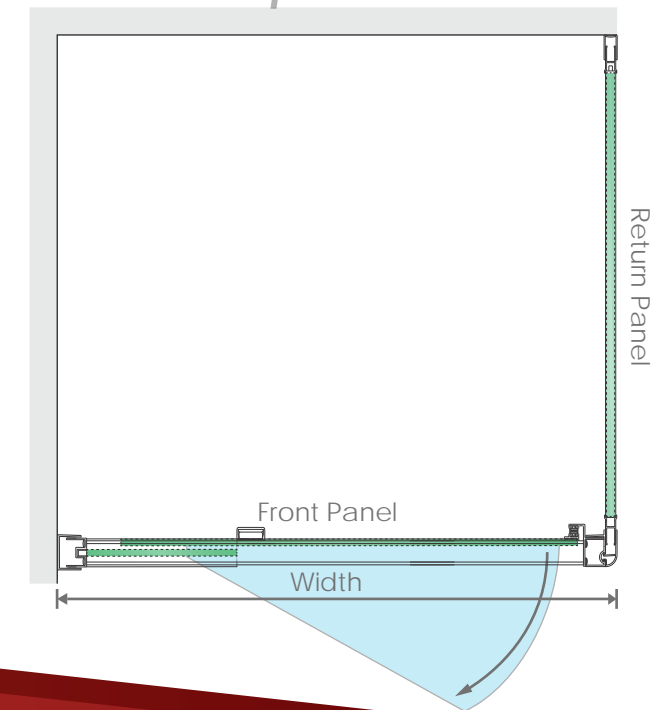

Available Configurations

← All panel sizes have a +80mm adjustable capability →

EDEN-T740 (P-Silver) & EDEN T-740B (Black)

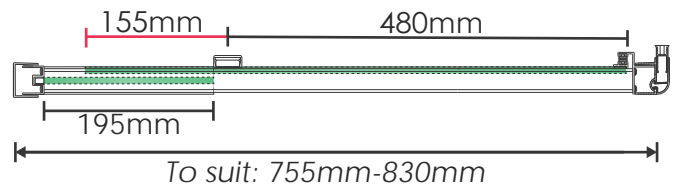

EDEN-T820 (P-Silver) & EDEN T-820B (Black)

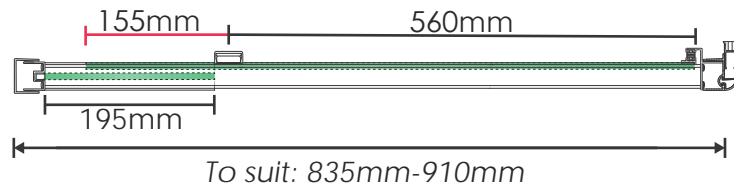

EDEN-T900 (P-Silver) & EDEN T-900B (Black)

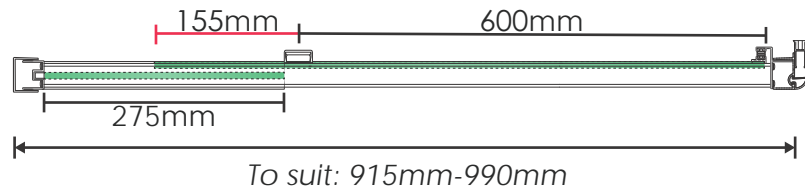

EDEN-T980 (P-Silver) & EDEN T-980B (Black)

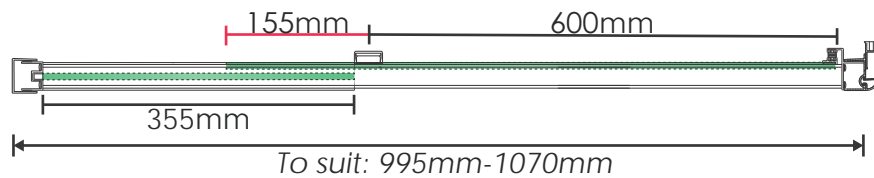

EDEN-T1060 (P-Silver) & EDEN T-1060B (Black)

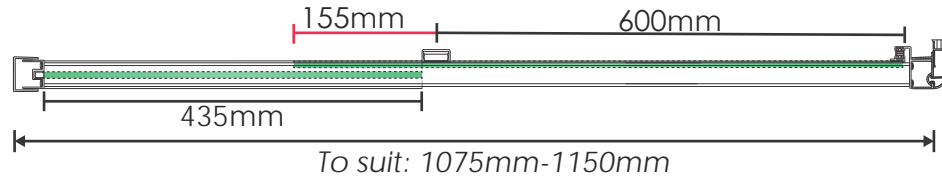

Available Configurations

EDEN-T1140 (P-Silver) & EDEN T-1140B (Black)

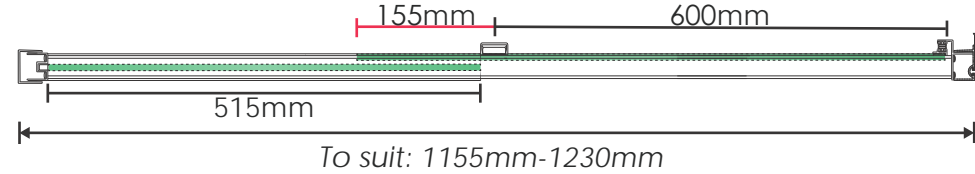

EDEN-T1220 (P-Silver) & EDEN T-1220B (Black)

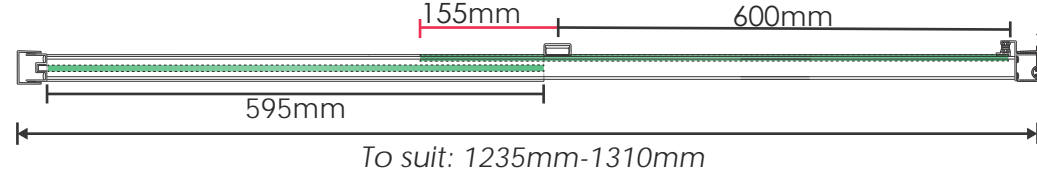

EDEN-T1300 (P-Silver) & EDEN T-1300B (Black)

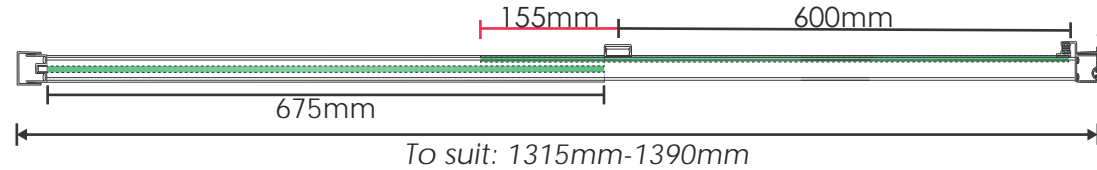

EDEN-T1380 (P-Silver) & EDEN T-1380B (Black)

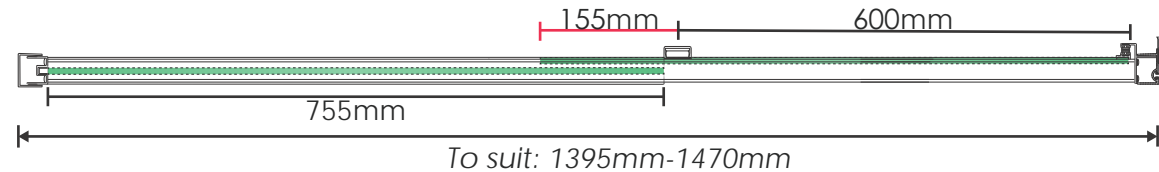

EDEN-T1460 (P-Silver) & EDEN T-1460B (Black)

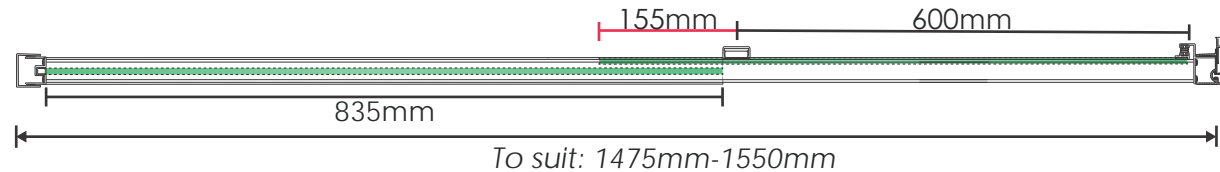

EDEN-T1540 (P-Silver) & EDEN T-1540B (Black)

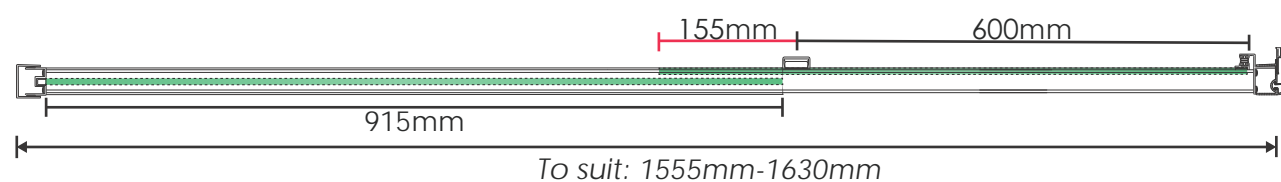

Adjustability

Versatility

The square series of our Eden range, utilises the same adjustable front, from our in-line system, and additionally uses an adjustable return panel to create a contemporary glass corner design.

As shown in the diagram below, the panel before the pivot of the door, slides along the rail, allowing you to fully control where the frame starts and finishes, with 80mm of adjustment! The outer clips are also adjustable, so if you're looking for a little more wiggle room, then we've got you covered!

The return panel works similarly, and allows for adjustment of 20mm, 10mm on each end! The square series return panel range is one of our larger selections and offers 22 different sizes to choose from!

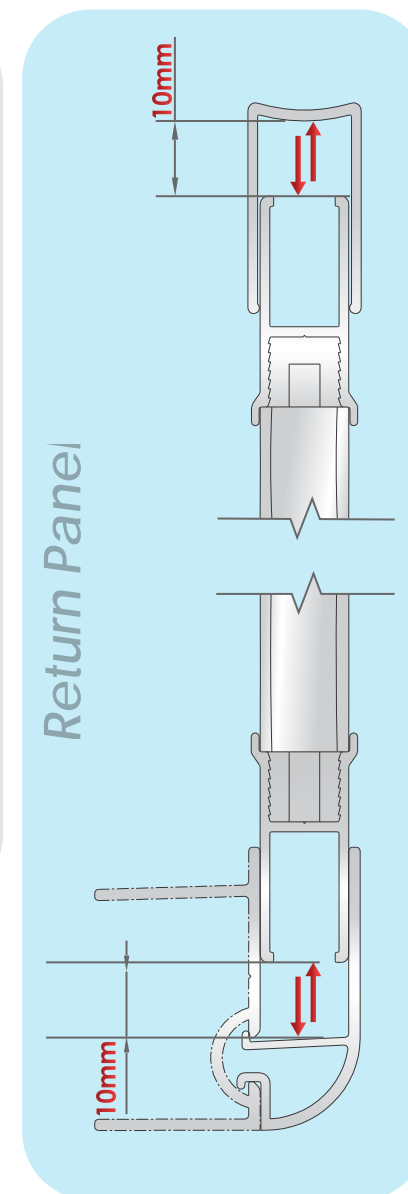

**See the next page
to view our entire range of
Eden Return Panels**

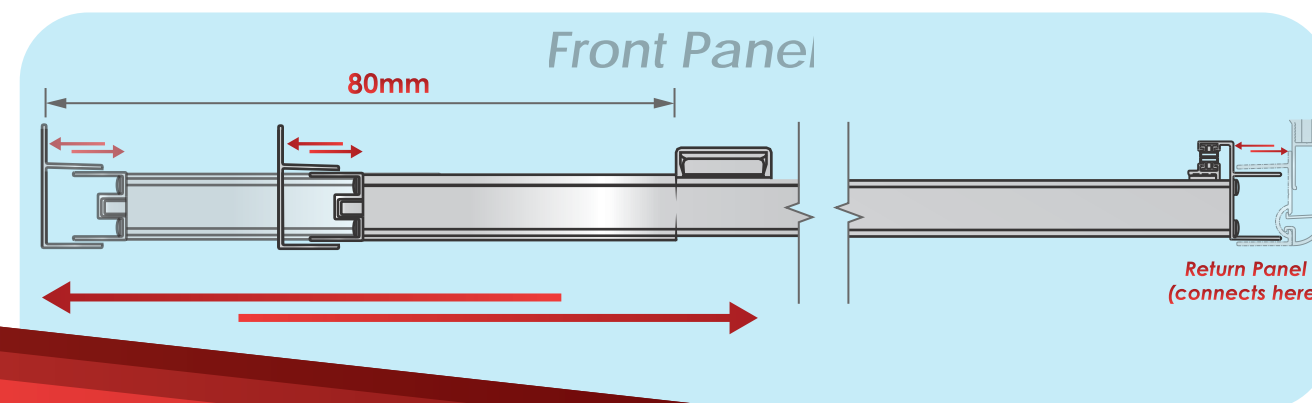

Eden Return Panel Size Range

Return Panels

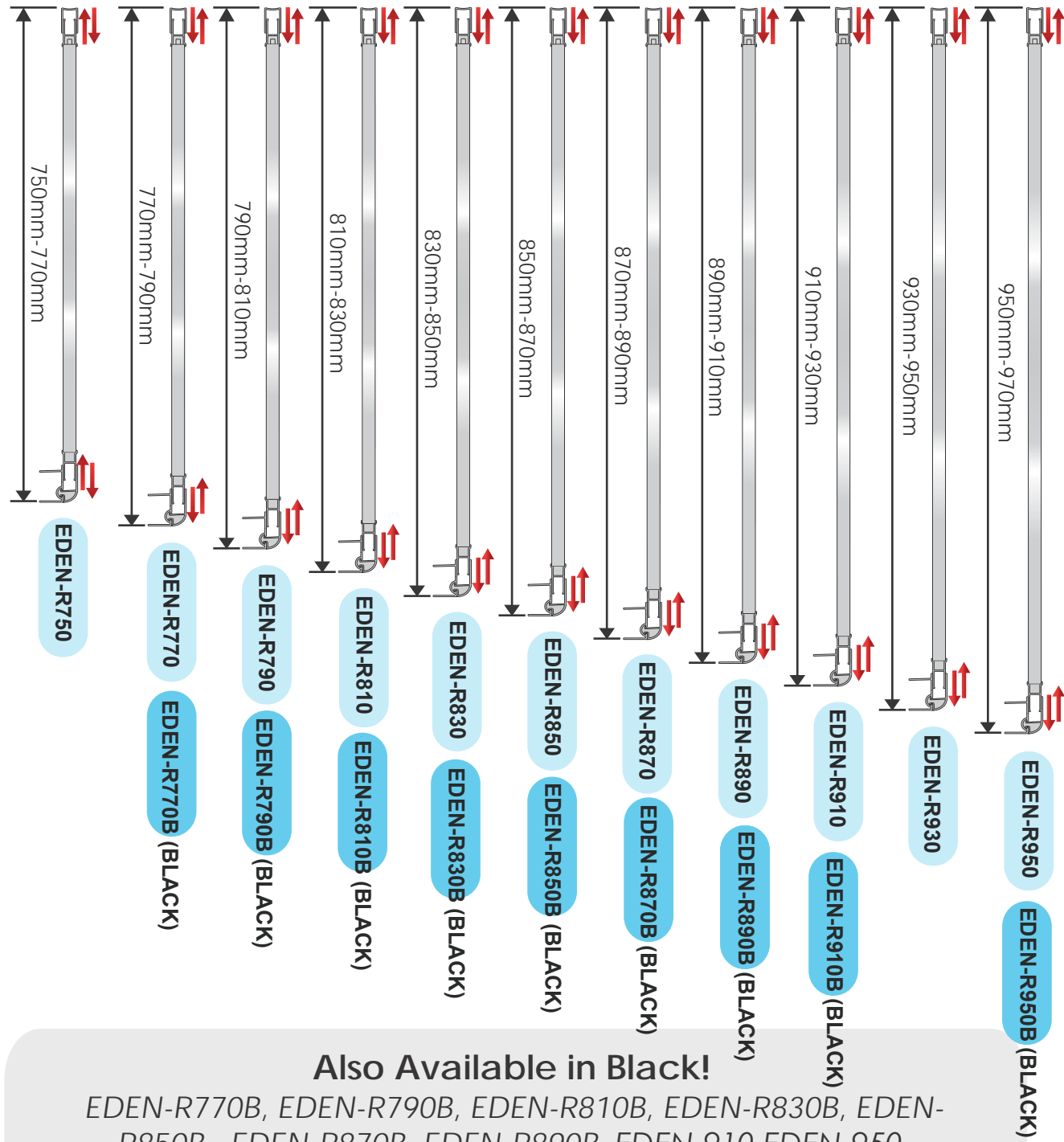

Also Available in Black!

EDEN-R770B, EDEN-R790B, EDEN-R810B, EDEN-R830B, EDEN-R850B, EDEN-R870B, EDEN-R890B, EDEN-910, EDEN-950, EDEN-R990B, EDEN-R1170B

Eden Return Panel Size Range

Return Panels (cont.)



Custom Panel

Make Your Own

Our Eden Range return panels can also be custom built. In the case where our standard sizes don't fit, you can easily purchase the components and cut it to size yourself.

To make your own panel, simply select the return panel components listed on the following page, and then find our laminated glass sizes below.

After selecting the glass you desire and components to suit, simply cut everything to fit the dimensions of your space and piece together your custom panel! Our laminated glass makes for easy cutting, and our slide-in components make for an even easier install!

Glass Sizes Available

Available in 2 different sizes:

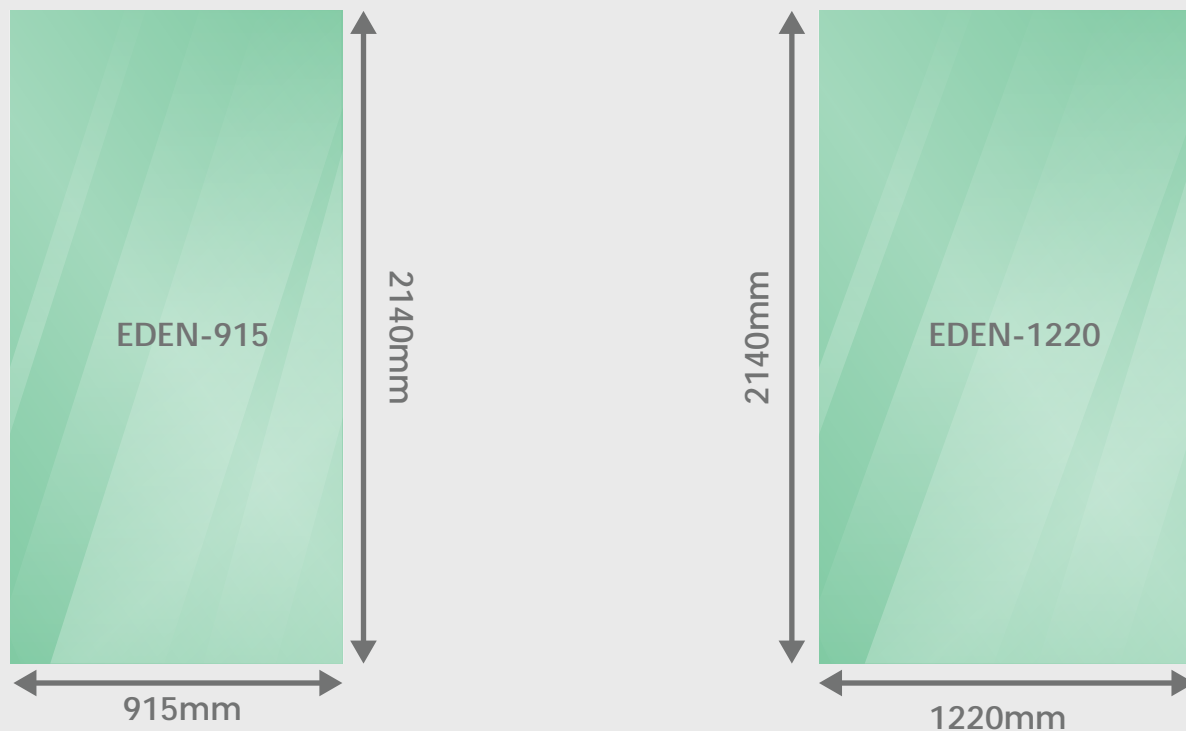

Custom Section



Vertical Section

Product ID: EDEN-VERT-SEC
Available in 2120mm lengths
Polished Anodised Finish



Top/Bottom Rail

Product ID: EDEN-TOP/BOT
Available in 2120mm lengths
Top & Bottom Use
Cut to fit
Polished Anodised Finish

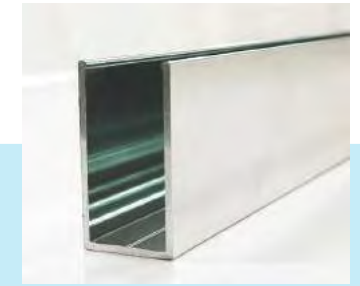

Wall Channel

Product ID: EDEN-WALL
Available in 2120mm lengths
Polished Anodised Finish

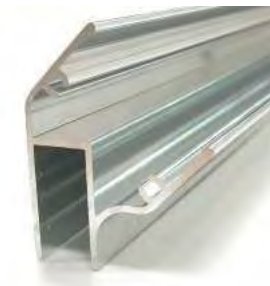

135° Section

Product ID: EDEN-135-SEC
Available in 2120mm lengths
Polished Anodised Finish

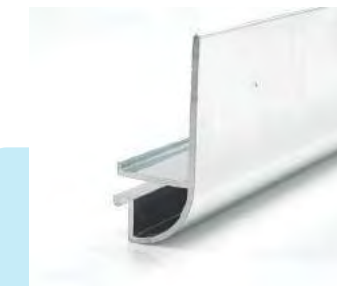

90° Section

Product ID: EDEN-90-SEC
Available in 2120mm lengths
Polished Anodised Finish



90° Caps

Product ID: EDEN-90-CAP
Corner covers, left & right
Polished Anodised Finish

Also Available in Black!

All components available in black! Visit our website, or see us in store for more information on our Eden Black Range

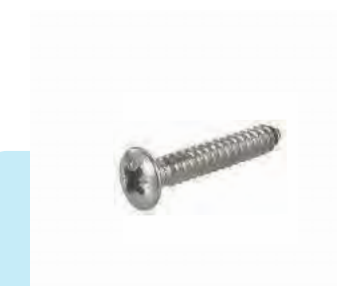

30mm Cross Pan Screw

Product ID: EDEN-ST4-30
4mm x 30mm
4 Gauge S304 stainless steel
Available in bags of 4



Guard Rubber

Product ID: EDEN-RUBBER
Suits 6.38mm glass
Available in 100m rolls
OR
Available per meter



Please except all errors. All drawings are for guidance purposes only and should not be the sole source for installing.

Prices for products can be found on: www.framelessdirect.com.au

Please always be safe and follow specific compliances for the jobs being carried out. All projects should be conducted safely and with the correct tools and precautions.

© Copyright 2018. Frameless Direct.

Frameless Direct

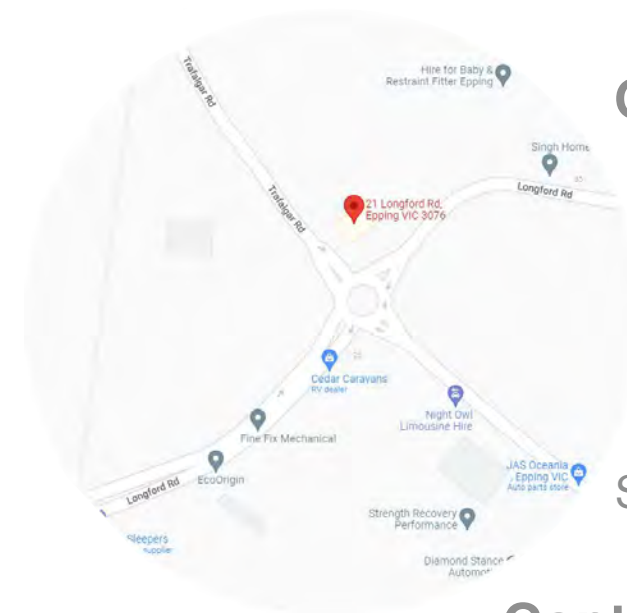

Opening Hours

Monday: 8am-4pm
Tuesday: 8am-4pm
Wednesday: 8am-4pm
Thursday: 8am-4pm
Friday: 8am-4pm
Saturday: Closed
Sunday: Closed

Contact Us

21 Longford Rd, Epping, Victoria. 3076

t: +61 3 9303 9008

t: +61 3 8339 2425



sales@framelessdirect.com.au



www.framelessdirect.com.au

Our Depot

